

# BOSS®



## Clima 3T

Mobile Aluminium Tower  
1450/850 Clima

3T - Through the Trapdoor Method

Instruction Manual



# Contents

## 1 Safety First

---

1.1	Introduction	2
1.2	Tower Designation	3
1.3	Maintenance - storage - transport	3

## 2 Building the Tower

---

2.1	Pre-Assembly Checks	4
2.2	Component Diagram	5
2.3	Quantity Schedule	6
2.4	Stabilisers	9
2.5	Assembly	10
2.5.1	Assembly for 1450 Towers	11
2.5.2	Assembly for 850 Towers	16
2.6	Dismantling	18

## 3 Using the Tower

---

3.1	Safety Checklist	19
3.2	Pre-Use Checklist	19
3.3	Use	20
3.4	Movement of the assembled prefabricated tower scaffold	21

# 1 Safety First

## 1.1 Introduction

---

Please read this instruction manual carefully.

THIS INSTRUCTION MANUAL SHALL BE AVAILABLE AT THE LOCATION OF USE OF THIS MOBILE ACCESS TOWER.

THIS PRODUCT SHALL ONLY BE USED IN ACCORDANCE WITH THIS MANUAL.



**FAILURE TO FOLLOW THESE INSTRUCTIONS MAY LEAD TO DEATH OR SERIOUS INJURY.**

IF ANY ASPECT OF THESE INSTRUCTIONS CONFLICTS WITH LOCAL REGULATIONS PLEASE CONTACT WERNER UK SALES & DISTRIBUTION LTD. FOR ADVICE.

Please note that diagrams are for illustrative purposes only.

Instruction manuals are also available to download at [www.bossacesstowers.com](http://www.bossacesstowers.com).

BoSS mobile aluminium towers are light-weight scaffold towers used throughout the building and construction industry for both indoor and outdoor access solutions where a stable and secure platform is required. Ideal for maintenance and installation work or short-term access, the highly versatile towers provide a strong working platform for a variety of heights.

Verification and assessment documentation is held by Werner UK Sales & Distribution Ltd.

If you need further information, design advice, additional instruction manuals or any other help with this product, please contact Werner UK Sales & Distribution Ltd. on +44 (0)1621 745900 or email [uk.customercare@wernerco.com](mailto:uk.customercare@wernerco.com).

### Compliances



The BoSS Clima mobile tower system has been designed, tested, approved and certified to EN 1004-1:2020.

This instruction manual is in compliance with EN1298-IM-en.

# 1 Safety First

## 1.2 Tower Designation

### EN 1004 3 8/12 XXXD H2

Design Code

Load Class (2 = 153kg/m<sup>2</sup> UDL, 3 = 204kg/m<sup>2</sup> UDL)

Max. Platform Height Outdoors (m)

Max. Platform Height Indoors (m)

Access Method

A = Stairway, B = Stair ladder, C = Inclined Ladder, D = Vertical Ladder

Clear Height Class (H1 = 1.85m, H2 = 1.90m)

## 1.3 Maintenance - storage - transport

- The BoSS mobile tower system is robust and requires little maintenance.
- All components and their parts should be regularly inspected to identify damage, particularly to joints.
- Refer to the BoSS Inspection Guidance for detailed inspection and maintenance advice, the guidance is available to download at: [www.bossacesstowers.com](http://www.bossacesstowers.com).
- Threads, hinges, and brace latches may be lubricated with light oil. Ensure oil does not contaminate climbing or walking surfaces.
- Safety labels should be kept legible. Replacement labels are available from Werner UK Sales & Distribution Ltd.
- Surfaces should be kept reasonably free of dried paint, plaster etc.
- Use of solvents on wooden platform surfaces and plastic components should be avoided.
- Components should be stored in clean, dry conditions with due care to prevent damage.
- During transportation ensure components are not damaged by excessive strapping forces.

## 2 Building the Tower

### 2.1 Pre-Assembly Checks

---

- Check overhead that the area into which the structure is to be erected contains no obstructions, particularly electrical or radio radiation hazards. The structure is conductive.
- Ensure the ground on which the mobile access tower is to be erected is capable of supporting the tower in use.
- Check the surface is level within the 210mm range of the adjustable legs.
- Adjustable legs should only be used for levelling purposes and never to gain extra height.
- Ensure distance from the ground to first climbing rung is less than 400mm.
- Only climb the tower from the inside using the access method provided.
- Tower scaffolds are not designed to be lifted or suspended.
- This tower provides a work platform. It must not be used to access other structures.
- Ensure the safe working load on the structure is not exceeded.
- Tools and materials should be lifted using a reliable lifting material (e.g. a strong rope) employing a reliable knot (e.g. clove hitch) to ensure safe fastening and always lift within the footprint of the prefabricated tower scaffold (i.e. within the area bounded by the stabilisers).
- Check this manual is available and its contents familiar to all those involved.
- If assembling outdoors; check the forecast windspeed. The assembled tower is certified to wind forces equating to 27mph, but handling components under those conditions would be hazardous. Also consider the wind funnelling effect of nearby buildings.
- Towers greater than 8.2m platform height are for indoor use only.
- This structure is designed to be self-supporting under the loading condition requirements of EN 1004-1:2020 and does not require tying in. Consideration should be given to potential wind conditions if the tower is left unattended.

## 2 Building the Tower

### 2.2 Component Diagram

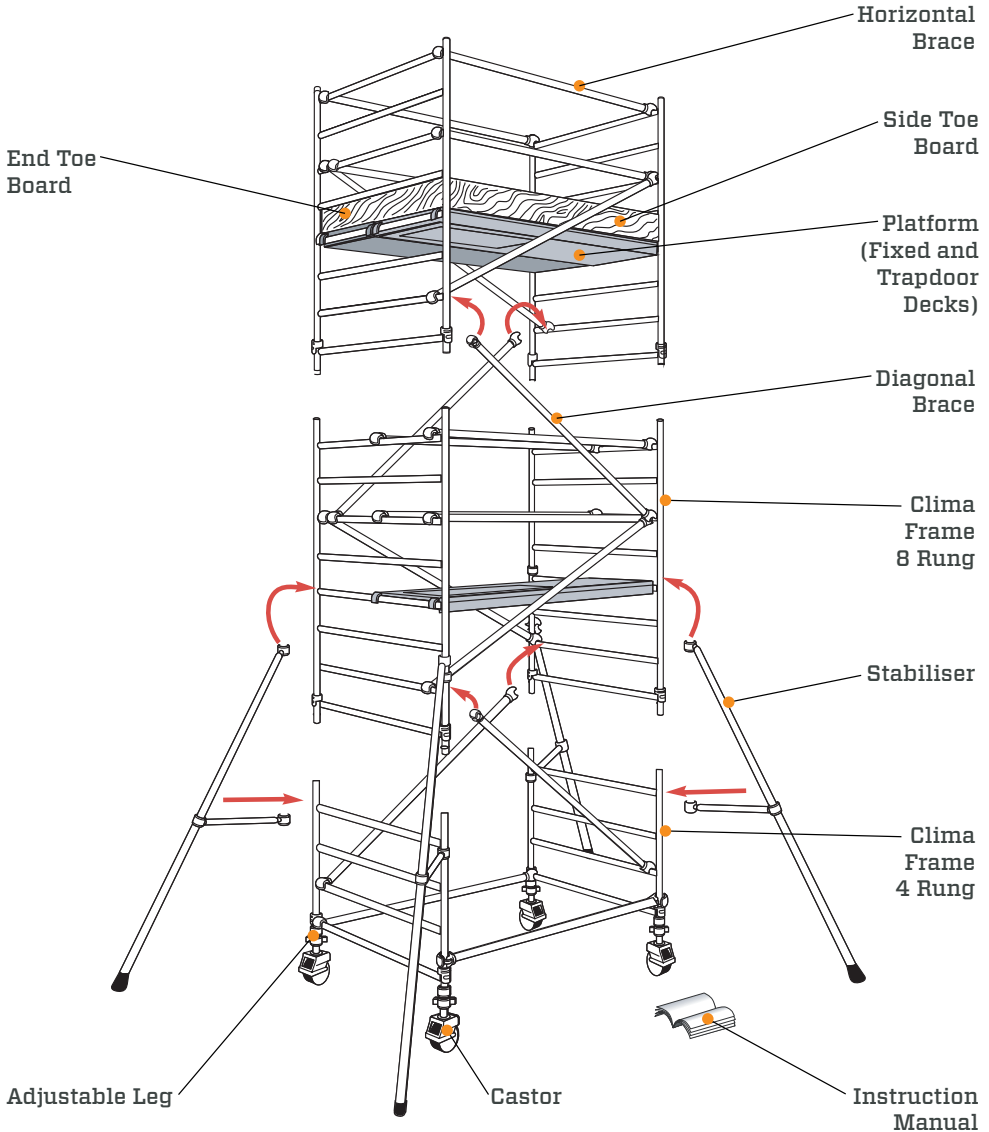





## BoSS 850 Clima to EN 1004: Available in 2 lengths - 1.8m and 2.5m

Component Code	Component Working Height (m)	Internal or External Use										Internal Use															
		2.2	2.7	3.2	3.7	4.2	4.7	5.2	5.7	6.2	6.7	7.2	7.7	8.2	8.7	9.2	9.7	10.2	10.7	11.2	11.7	12.2	12.7	13.2	13.7	14.2	
32842300	Castor 150mm	4	4	4	4	4	4	4	4	4	4	4	4	4	4	4	4	4	4	4	4	4	4	4	4	4	4
33551300	Adjustable Leg	4	4	4	4	4	4	4	4	4	4	4	4	4	4	4	4	4	4	4	4	4	4	4	4	4	4
39251300	Clima Frame 850 4 Rung	2	-	-	2	2	-	-	2	2	-	-	2	2	-	-	2	2	-	-	2	2	-	-	2	2	-
39451300	Clima Frame 850 6 Rung	-	2	-	2	-	2	-	2	-	2	-	2	-	2	-	2	-	2	-	2	-	2	-	2	-	-
39351300	Clima Frame 850 8 Rung	2	2	4	2	4	4	6	4	6	6	8	6	8	8	10	8	10	8	10	10	12	10	12	10	12	12
30151100/30251100	Fixed Deck 1.8m / 2.5m	-	1	-	-	-	1	-	-	-	1	-	-	-	1	-	-	-	1	-	-	-	1	-	-	-	-
30451100/30551100	Trapdoor Deck 1.8m / 2.5m	1	1	2	2	2	2	3	3	3	3	4	4	4	4	5	5	5	5	5	5	6	6	6	6	6	6
31251300/34851300	Horizontal Brace 1.8m / 2.5m (Red)	6	10	10	10	10	14	14	14	14	18	18	18	18	18	22	22	22	22	22	22	26	26	26	26	26	26
31351300/31451300	Diagonal Brace 2.1m / 2.7m (Blue)	4	6	6	8	8	10	10	12	12	14	14	16	16	18	18	20	20	22	22	22	26	26	24	24	24	24
30450900/30550900	Side Toe Board 1.8m / 2.5m	2	2	2	2	2	2	2	2	2	2	2	2	2	2	2	2	2	2	2	2	2	2	2	2	2	2
30250900	End Toe Board 0.85m	2	2	2	2	2	2	2	2	2	2	2	2	2	2	2	2	2	2	2	2	2	2	2	2	2	2
30150900	Toe Board Holder	4	4	4	4	4	4	4	4	4	4	4	4	4	4	4	4	4	4	4	4	4	4	4	4	4	4
31751300	SP7 Fixed Stabiliser	4	4	4	4	4	4	-	-	-	-	-	-	-	-	-	-	-	-	-	-	-	-	-	-	-	-
31851300	SP10 Telescopic Stabiliser	-	-	-	-	-	-	-	-	-	-	-	-	-	-	-	-	-	-	-	-	-	-	-	-	-	-
31951300	SP15 Telescopic Stabiliser	-	-	-	-	-	-	-	-	-	-	-	-	-	-	-	-	-	-	-	-	-	-	-	-	-	-
Tower Total Self-weight 1.8m (kgs)		101	129	133	144	147	175	199	210	213	241	246	273	276	304	309	319	322	351	355	365	365	368	368	368	368	368
Tower Total Self-weight 2.5m (kgs)		119	155	160	172	177	212	238	250	255	290	295	325	330	348	353	365	370	406	411	423	423	428	428	428	428	428
Max. Exerted Leg Load 1.8m (kgs)		85	90	95	100	105	110	116	122	128	134	140	147	156	158	163	169	174	179	184	190	195	195	195	195	195	195
Max. Exerted Leg Load 2.5m (kgs)		120	122	124	126	128	130	133	137	140	144	147	149	181	181	181	191	201	211	221	231	241	241	251	251	251	251

## 2 Building the Tower

### Assembly Variations

This section lists the permitted component variation from the Quantity Schedule.

Note: These substitutions must be made before assembly.

Stabilisers with Universal Clamps may be substituted:

Component Code	Description	Weight (kg)
31751400	SP7	4.0
31851400	SP10	9.0
31951400	SP15	13.1

Other Castor sizes and types may be substituted:

Component Code	Description	Weight (kg)
31842300	Diameter 150mm (Tyred)	3.2
32942300	Diameter 200mm	3.9
31942300	Diameter 200mm (Tyred)	3.9

If side walk-through access is required at the base of 4.2m, 6.2m, 8.2m, 10.2m or 12.2m platform height towers, high clearance frames may be used in place of the four lower diagonal braces and two lower horizontal braces.

High clearance frames must not be used in conjunction with walk-through frames.

Component Code	Description	Weight (kg)
30051500	High Clearance Frame 1.8m	10.0
30151500	High Clearance Frame 2.5m	12.0

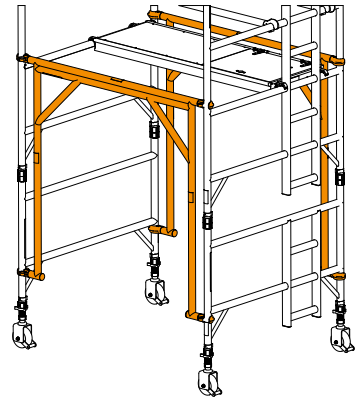

## 2 Building the Tower

If end walk-through access is required at the base of 2.2m, 4.2m, 6.2m, 8.2m, 10.2m or 12.2m platform height, 1450 wide towers, walk-through frames may be used.

In this case the 1m clima frames must be fitted above the walk-through frames.

Walk-through frames must not be used in addition to high clearance frames.

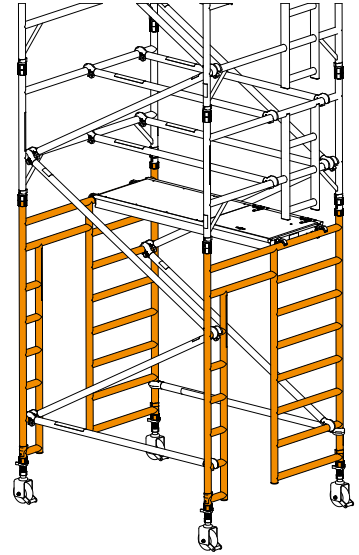

Component Code	Description	Weight (kg)
33151700	Walk-through Frame 2.0m	10.8

### 2.4 Stabilisers

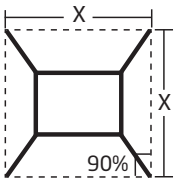

	Double Width 1450 Tower		Single Width 850 Tower	
	Platform Length 1.8m	Platform Length 2.5m	Platform Length 1.8m	Platform Length 2.5m
SP7	3351	3629	2294	3201
SP10	4789	5100	4458	4734
SP15	5520	5838	5195	5485

SP10 and SP15 stabilisers must always be fully extended.

Position the lower clamp so that the arm is as close to horizontal as possible. Adjust the position of the top clamp to ensure the stabiliser foot is in firm contact with the ground. Ensure the clamps are secure.

## 2 Building the Tower

### 2.5 Assembly

This tower structure must be assembled, and components oriented, in accordance with this instruction manual. Deviation from this instruction manual is not permitted.



**THIS TOWER MUST NOT BE USED AS AN ANCHOR POINT FOR PERSONAL FALL PROTECTION EQUIPMENT.**

- No tools are required for assembly.
- The assembly uses the 3T (Through the Trapdoor) method that provides collective fall protection.
  - From the sitting position in the trapdoor opening fit all guardrails before standing on the platform.
  - Fit braces in the locations described and ensure the claws are locked.

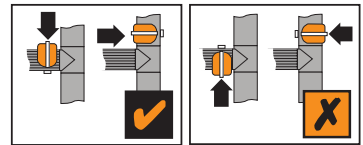

- The tower may be assembled by a single person, but it is recommended that two or more are used to pass up components on the taller assemblies.
- Components must be lifted within the footprint of the tower using a reliable method such as a strong rope with a clove hitch knot.
- Always start assembly with the smallest height frames at the base.

Platform Height (m)	Frame at Base
2.2, 3.7, 4.2, 5.7, 6.2, 7.7, 9.7, 10.2, 11.7, 12.2	2 Rung
2.7, 4.7, 6.7, 8.7, 10.7	3 Rung
3.2, 5.2, 7.2, 9.2, 11.2	4 Rung

- Where all three frames are specified, start with the 2 rung, 3 rung next and 4 rung on top. Refer to the quantity schedule for details.
- Castor brakes should be locked as soon as the tower base is in position.
- The tower base should be levelled to within 0.6° before continuing the assembly.
- The adjustable legs are for levelling the tower only and not to be used to gain extra height.
- Ensure when the base is levelled the distance from the ground to the first climbing rung is less than 400mm.
- Stabilisers of the size specified in the quantity schedule should be fitted at the earliest opportunity.

## 2 Building the Tower

### 2.5.1 Assembly for 1450 Towers

**1** Push four castors onto four adjustable legs. Insert adjustable legs into two end frames as shown. Lock castor brakes.

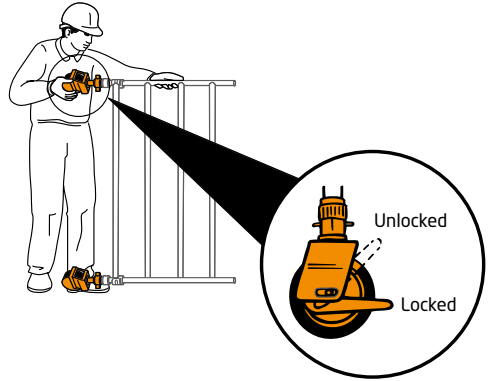

**2** Fit one horizontal brace (red) onto the vertical of an end frame, just above the bottom rung, with the claw facing outwards.

Note: All locking claws must be opened before fitting.

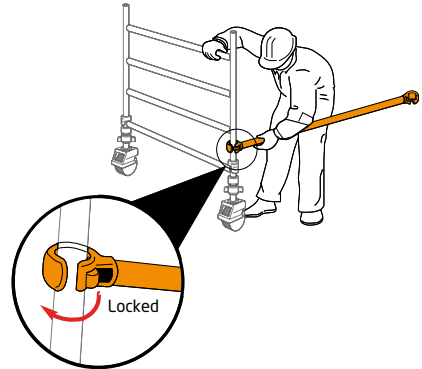

## 2 Building the Tower

**3** Position the second end frame as shown and at the other end of the horizontal brace onto the vertical, just above the bottom rung. Fit a second horizontal brace between the bottom rungs on the other side of the frames to square the tower.

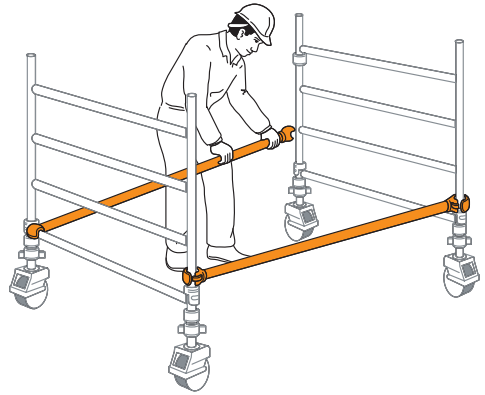

**4** Fit two additional end frames and check that the frame interlock clips are engaged. Fit two diagonal braces (blue) in opposing directions between the 2<sup>nd</sup> and the 6<sup>th</sup> rungs. Ensure the frames are vertical and level by checking with a spirit level and setting the adjustable legs as required.

Important - Only use the adjustable legs to level the tower and not to gain extra height.

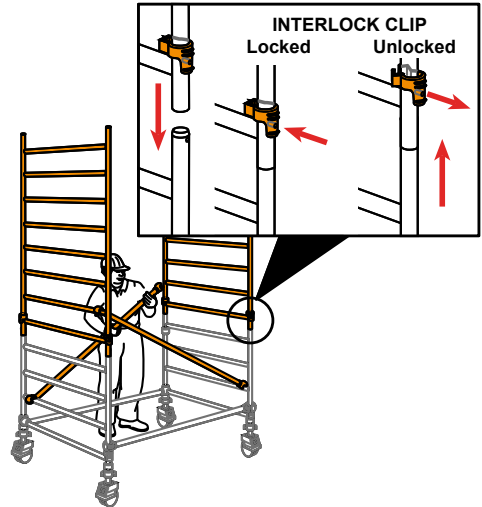

Fit stabilisers (see notes on **page 9**).

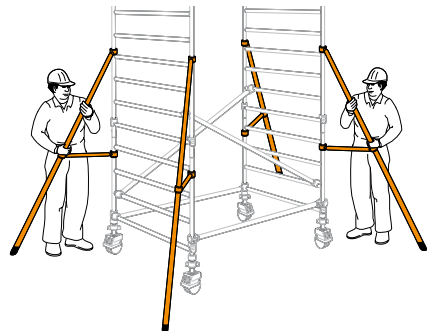

## 2 Building the Tower

**5** Fit a temporary deck on the lowest rungs. Fit a trapdoor deck on the 8<sup>th</sup> rung (2.0m) on one side of the tower. Ensure that the trapdoor is positioned with the hinges towards the outside of the tower as shown. Climb the end frame below the trapdoor on the inside of the tower, and from within the protected trapdoor position, fit horizontal braces on the 10<sup>th</sup> and 12<sup>th</sup> rungs (in that order) on both sides of the deck.

**Do not climb onto the deck until all guardrails are in place.**

When horizontal braces are fitted as guardrails, they should be 0.5m and 1.0m (2 and 4 rungs) above the deck level.

Remove the temporary deck from the lowest rung.

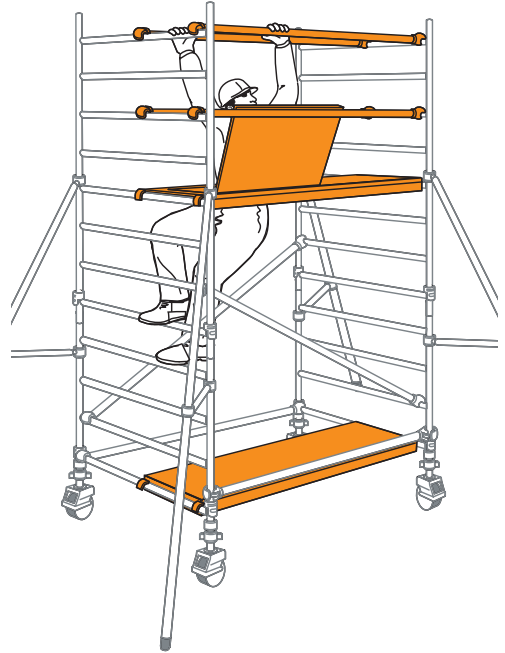

**6** Fit the next pair of diagonal braces in opposing directions between the 6<sup>th</sup> and 10<sup>th</sup> rungs add two additional end frames.

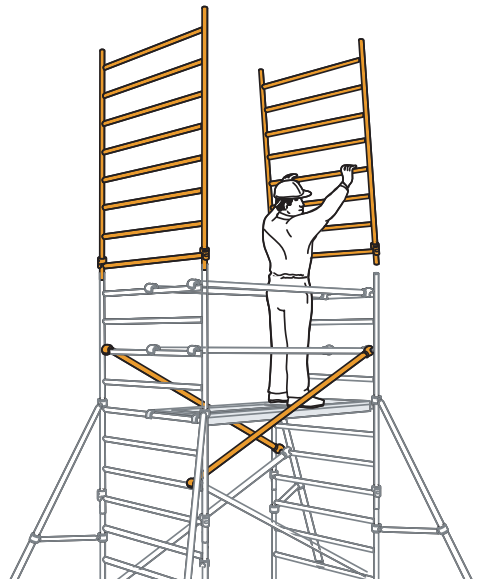

## 2 Building the Tower

**7** Add two more diagonal braces between the 10<sup>th</sup> and 14<sup>th</sup> rungs. If finishing at this height (4.2m platform), the fixed deck should be repositioned to the 16<sup>th</sup> rung on the opposite side of the tower to the trapdoor deck. Fit a trapdoor deck alongside it with the hinges towards the outside of the tower and the trapdoor in line with the one below. Climb the tower and from the protected trapdoor position, fit the horizontal braces as guardrails on both sides at 2 and 4 rungs (0.5 and 1.0m) above the platform level. At the final level, further diagonal braces should be added on both sides of the tower as shown.

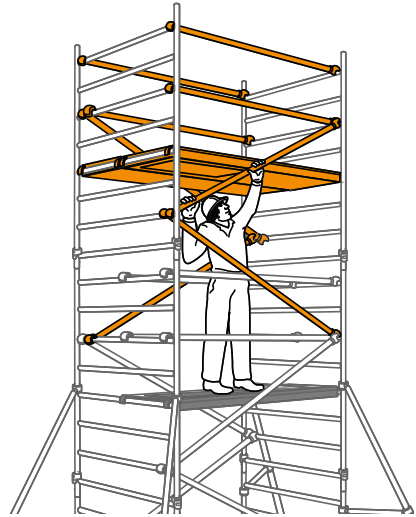

### When building beyond a 4.2m platform height

**8** Continue to add pairs of end frames, diagonal braces and fit trapdoor decks as shown in the previous steps. At every platform level, add horizontal braces as guardrails at 2 and 4 rungs above the platform.

Fit these guardrail braces from the protected trapdoor position. Do not climb onto the platform until all guardrails are in place.

Continue until the required height is reached. Re-position the fixed deck to the required platform height and fit a trapdoor deck alongside it as shown in **Stage 7**. Fit the guardrails as shown in **Stage 7**.

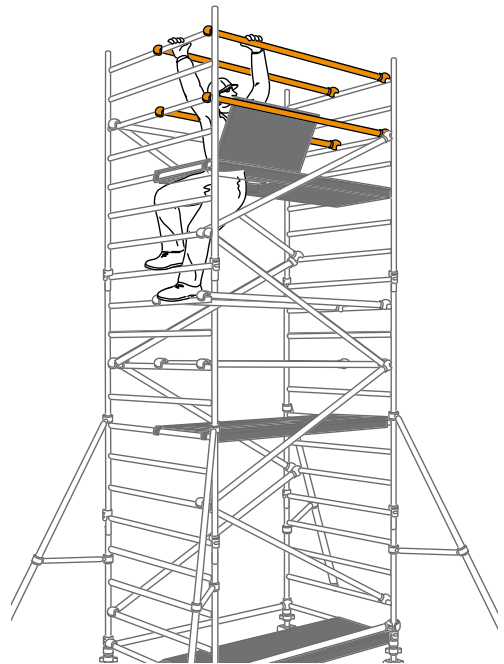



## 2 Building the Tower

9 Fit toe boards.

The tower is now complete.

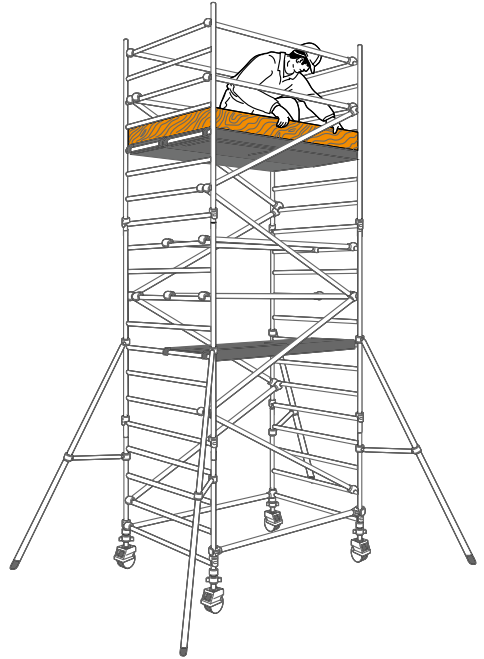

## 2 Building the Tower

### 2.5.2 Assembly for 850 Towers

The procedure illustrated shows a tower starting with an 8 rung frame.

**1** Insert adjustable leg/castor assemblies into end frames and lock the castors, (see diagram **Step 1 - page 11**). Fit two horizontal braces to the 850 end frames as shown in **steps 2 and 3** for the 1450 tower procedure (**pages 11 and 12**). Ensure that the frames are vertical and level by checking with a spirit level and setting the adjustable legs required.

**2** Fit a trapdoor deck on the 4<sup>th</sup> rung. Fix the horizontal braces (red) as guardrails on the 6<sup>th</sup> and 8<sup>th</sup> rungs (2 and 4 rungs above the platform) on both sides of the tower.

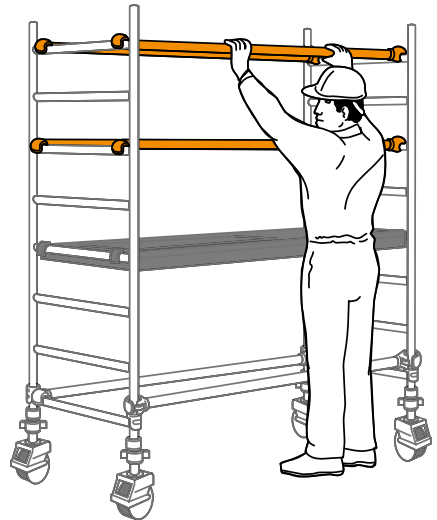

## 2 Building the Tower

**3** Fit two diagonal braces (blue) in opposing directions between the 2<sup>nd</sup> and 6<sup>th</sup> rungs. Ensure the frames are vertical and level by checking with a spirit level and setting the adjustable legs as necessary. Fit the next pair of end frames and check the frame interlock clips are engaged. Fit stabilisers (see notes on **page 9**).

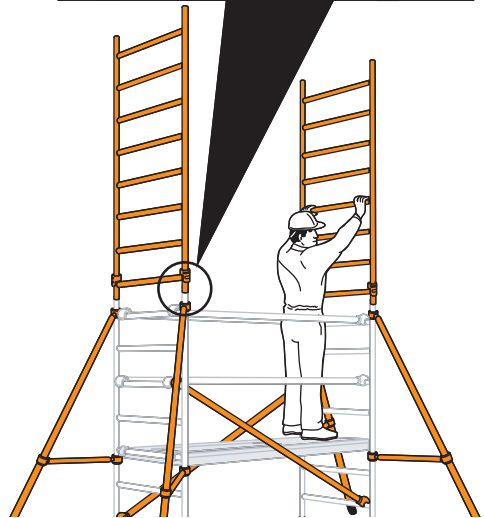
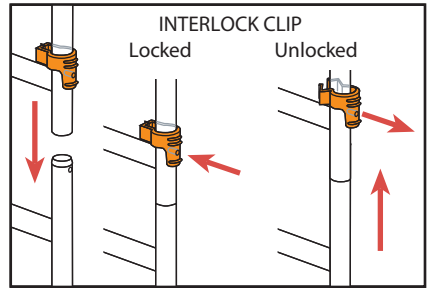

**4** Fit two pairs of diagonal braces in opposing directions between the 6<sup>th</sup> and 10<sup>th</sup> rungs and the 10<sup>th</sup> and 14<sup>th</sup> rungs. Locate a trapdoor deck on the 12<sup>th</sup> rung.

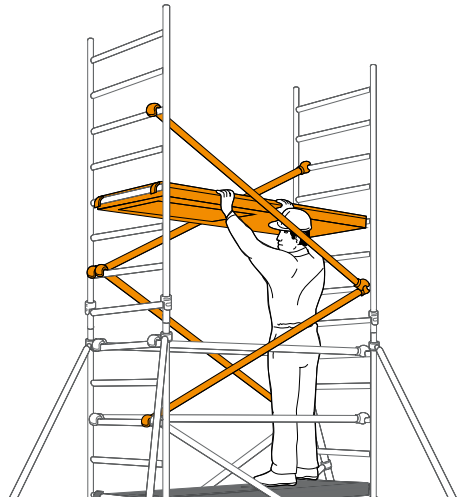

## 2 Building the Tower

**5** Climb up the inside of the tower and from the protected position of the trapdoor, fit horizontal braces as guardrails (on both sides) to the 14<sup>th</sup> and 16<sup>th</sup> rungs (2 and 4 rungs above the platform in that order).

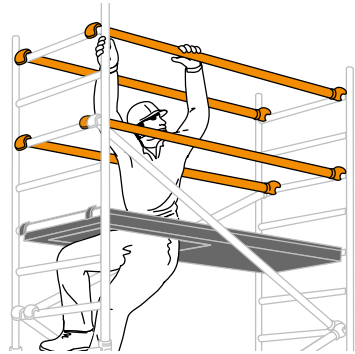

**6** Continue the procedure until the required working height is reached, adding additional pairs of end frames, diagonal braces and fitting trapdoor platforms, as shown on previous steps. At every platform level, add horizontal braces as guardrails at 2 and 4 rungs above the platform (in that order) on both sides of the platform (as shown in **Step 5**).

Fit these guardrail braces from the protected trapdoor position.

**Do not climb onto the platform until all guardrails are in place.**

At the final level, diagonal braces should be added to each side of the tower as shown. Fit the toe boards.

**The tower is now complete.**



### 2.6 Dismantling

To dismantle the tower, reverse the assembly procedure.

When removing the guardrails unlock the four claws furthest from the trapdoor and return immediately to the protected position within the trapdoor. The other claws can then be unlocked, and the guardrails removed from the tower.

## 3 Using the Tower

### 3.1 Safety Checklist





---

This inspection must be carried out before initial use, after moving the tower, if any environmental condition change that may affect the tower and at regular intervals determined by local regulations.

Local regulations may also specify other information to be supplied to the user. These regulations must be followed.

### 3.2 Pre-Use Checklist

---

Tower upright and level to within 0.6°	
Castor brakes locked	
All interlock clips engaged	
Braces/Guardrails correctly positioned	
All claws latched	
All platform wind latches engaged	
Correct stabiliser size fitted and positioned	
Toe boards fitted to working platform	
Instruction manual available to user	

---

## 3 Using the Tower

### 3.3 Use

---

- This tower must not be used as an anchor point for personal fall arrest equipment.
- The tower must only be climbed on the inside, using the access method specified.
- This tower provides a work platform. It must not be used to access other structures.
- Raising and lowering tools and materials must only be conducted within the tower footprint.
- Ensure the safe working load on the structure is not exceeded. See tower designation.
- Do not use boxes, stepladders or other objects to gain extra height.
- The adjustable legs are for levelling the tower only. They must not be used to gain extra height.
- Beware of horizontal forces that might cause instability. Maximum horizontal force = 30kg.
- Beware of high winds. This tower has been assessed as a freestanding structure for wind loads equating to 27mph (43kph, 12m/s). If greater windspeeds are forecast the tower must be moved to a sheltered location or dismantled while it is still safe to do so.
- Sheets, tarpaulins, or signage must not be attached to this tower outdoors.
- Towers above 8.2m platform height are for indoor use only.

## 3 Using the Tower

### 3.4 Movement of the assembled prefabricated tower scaffold

---

Ensure gloves or other suitable hand protection is worn.

#### Before

- Survey the route to be taken. Assess the ground condition/slope and any overhead obstructions or hazards.
- Tower stability will be improved by reducing the height before movement.
- If there is any doubt about the safety of the move the tower must be dismantled and reassembled in the new location.
- This tower is not designed to be lifted or suspended.
- Ensure there are no persons, tools, or materials on the tower.
- Release the castor brakes.
- Release the stabiliser top clamp to allow the feet to be raised a maximum of 25mm. Re-tighten the clamps.

#### During

- The tower must be moved only by manual effort, pushing at the base of the tower.
- Constant attention must be given to the position of the castors, stabiliser feet and the top of the tower.
- If there is any resistance to movement, stop and investigate the reason before continuing.

#### After

- As soon as the move is complete; lock the castor brakes, lower the stabiliser feet, and perform the pre-use inspection.



For further information and support for the  
Clima or any other products and  
services, please contact:

Werner UK Sales & Distribution Ltd.  
Blackwater Trading Estate,  
The Causeway, Maldon,  
Essex, CM9 4LJ,  
United Kingdom

WernerCo Hungary Kft.  
6000 Kecskemét,  
Szt. Istvan Krt. 19.

☎ +44 (0)1621 745900

✉ [uk.customer@wernerco.com](mailto:uk.customer@wernerco.com)

🌐 [bossacesstowers.com](http://bossacesstowers.com)

Werner UK Sales & Distribution Ltd.  
is a manufacturer member of:

